



 SWISS MADE  
SWISS TECHNOLOGY

**SERIES 365, 330, 335**  
MOISTURE ANALYZERS



## PRECISA DNA: ZERO COMPROMISE

Laboratory and industrial technicians are aware of the significance of the results they provide. That is why they are unwilling to accept any compromise in their field of work. This is precisely why leading specialists around the world place their trust in Precisa and have done for decades.

## PRECISA DNA: MOISTURE ANALYZER

Moisture Analyzers from Precisa - for efficient measurements and accurate results. As the leading manufacturer of thermogravimetric analytical equipment, Precisa excels with an extensive range of moisture analysis equipment, meeting highest demands in research, production and quality control.

## PRECISA DNA: SWISS PRECISION

Precisa products are prime examples of Swiss perfection and reliability. They are tried and tested in both demanding laboratory environments and industrial applications, and are subject to rigorous quality controls throughout the entire manufacturing process. Precisa invests continuously in developing new technologies and employs a highly qualified team. The result is a state-of-the-art range of precision instruments for the most exacting demands.



## HIGH PERFORMANCE

Moisture and water content have a defining influence on the quality and processing of materials, as well as on the price of raw materials and finished products in many industries including food, animal feeds, chemical and pharmaceutical products, construction materials etc.

The use of compact and robust precision moisture measuring instruments in the laboratory and in production increases efficiency and saves time and costs. Furthermore, productivity is enhanced by the fully automatic moisture analysis of samples, and the corresponding generation of measurement documentation. All models of the Series 365 EM, 330 XM and 335 XM provide fast, error-free moisture analysis, using highest degrees of measurement performance and precision.

Simple to use and service-friendly to maintain, the Series 365 EM, 330 XM and 335 XM are the results of Swiss precision in engineering and production, which guarantees reliability, robustness and an extensive life of error-free operation at highest levels of precision.

## SERIES 365

With model EM 120-HR, Precisa is setting new standards in the demanding area of high-end moisture analyzers.

The flagship model combines ease-of-use and sophisticated customizing features for advanced and most demanding applications.

EM 120-HR is an innovative, high-tech moisture analyzer, which includes latest technical developments, unique performance features, best user-interface in a modern design, yet in a compact form with a small footprint. Those users who will not accept any compromise in their working environment may enjoy the reassuring certainty that for many years they can rely on an extremely accurate instrument which features the latest technology and renowned Swiss quality. Day after day.

# SERIES 365



Compact and Modern Design



Choice of Heating Source



Graphic Display for Easy Guidance and Real Time Results.

## PRECISA EM 120-HR

### Readability 0.001 % / 0.01 %

The EM 120-HR instrument for fast and accurate moisture analysis with a wide range of methods; sophisticated and simple to operate, complying to the most stringent standards.

### Highly Precise Technology

- Weighing range 124 g
- Adjustable readability: 0.1 mg / 0.001 % and 1 mg / 0.01 %
- High temperature range up to 230°C
- Automatic self calibration system (SCS)
- Bright graphic display
- Extended memory capacity, 100 methods
- Choice of heat element: halogen, infrared, infrared dark radiator
- USB and RS232 interfaces as standard
- Selectable heating modes: standard, boost, smooth

### Intuitive User Interface

- Freely programmable display
- Graphic presentation of the analysis
- Choice of auto stop criteria settings

### Quality Assurance

- Compliance with GLP and GMP
- Numerical and statistical analysis available
- Real-time observation of analysis

### Versatile Connectivity

Advanced slide-in module technology: USB Host, Ethernet wired, Ethernet wireless, Bluetooth and others.



# SERIES 330, 335



Robust and Simple to Operate



Easy Sample Access



Menu-driven, Screen-guided Applications

## PRECISA XM 60 / XM 66 / XM 50

### Readability 0.001 % / 0.01 %

High-end units for customers with limited number of methods. These instruments are robust, provide a high degree of precision and are simple to operate.

### The Versatile All-Round Moisture Determination Solution

- Sturdy construction, perfect for all laboratory and production environments
- Weighing range up to 310 g
- Readability up to 0.1 mg / 0.001%
- High temperature range of 230°C
- Temperature step of 1°C
- High contrast, bright vacuum fluorescent display
- Memory storage of up to 20 methods
- Interface RS232
- Choice of radiation heat source: halogen, infrared, infrared dark radiator
- Selectable heating modes: standard, boost, smooth

### Simple, Fast and Accurate

- Variety of start-up and end-point control selections for optimum control
- Language independent prompts operated by symbol keys
- Easy access sample holder

### Quality Assurance

- Results printed in GLP guideline format
- Numerical and statistical analysis available
- Real-time results shown in display
- Special version without glass for the food industry
- XM 66 with increased weighing range of 310 g and special software for the rapid moisture results for sewage and waste water treatment plants
- XM 50 the all-rounder with strain gauge weighing cell, appropriate for rough working environments.

# MODELS

## SERIES 365

Model	Capacity	Readability	Repeatability	Linearity	Temperature Range	Pan Size (mm)	Response Time
EM 120-HR	124 g	0.1 mg / 0.001%	1 g / 0.1 % 10 g / 0.01 %	0.2 mg	30 - 230°C	ø 100	4 s

## SERIES 330

Model	Capacity	Readability	Repeatability	Linearity	Temperature Range	Pan Size (mm)	Response Time
XM 60-HR	124 g	0.1 mg / 0.001 %	1 g / 0.1 % 10 g / 0.01 %	0.2 mg	30 - 230°C	ø 100	4 s
XM 60	124 g	1 mg / 0.01 %	1 g / 0.2 % 10 g / 0.02 %	1.5 mg	30 - 230°C	ø 100	3 s
XM 66	310 g	1 mg / 0.01 %	1 g / 0.2 % 10 g / 0.02 %	1.5 mg	30 - 230°C	ø 100	3 s

## SERIES 335

Model	Capacity	Readability	Repeatability	Linearity	Temperature Range	Pan Size (mm)	Response Time
XM 50	52 g	1 mg / 0.01%	1 g / 0.5 % 10 g / 0.05 %	3.0 mg	30 - 170°C	ø 100	4 s

## PRODUCT SPECIFICATIONS

Model	Dimensions (WxLxH)	Net Weight (kg)
XM Models	218 x 340 x 177 mm	6.2
EM Models	240 x 380 x 177 mm	6.7

## ITEM NUMBERS\*

Radiator	EM 120-HR	XM 60-HR	XM 60	XM 66	XM 50
Halogen radiator, 230 V	365-9245-001	330-9243B-001	330-9324B-001	330-9329B-001	335-9360-001
Halogen radiator, 115 V	365-9245-002	330-9243B-002	330-9324B-002	330-9329B-002	335-9360-002
Infrared radiator, 230 V	365-9245-003	330-9243B-003	330-9324B-003	330-9329B-003	335-9360-003
Infrared radiator, 115 V	365-9245-004	330-9243B-004	330-9324B-004	330-9329B-004	335-9360-004
Infrared dark radiator, 230 V	365-9245-007	330-9243B-007	330-9324B-007	330-9329B-007	335-9360-007
Infrared dark radiator, 115 V	365-9245-008	330-9243B-008	330-9324B-008	330-9329B-008	335-9360-008

\* The item numbers include the moisture analyzer with the corresponding heating source

# OPTIONS & ACCESSORIES

Accessories	EM 120-HR	XM 60-HR	XM 60	XM 66	XM 50
Sample pans, aluminum, Ø 100mm, set of 80 pieces	350-2032	350-2032	350-2032	350-2032	350-2032
Sample pan reusable, stainless steel, Ø100mm, 1 piece	330-2018	330-2018	330-2018	330-2018	330-2018
Fiberglass filters, Ø 90mm, set of 100 pieces	350-4130	350-4130	350-4130	350-4130	350-4130
Temperature calibration disc, sensor - type K	350-8580	350-8580	350-8580	350-8580	350-8580
Temperature calibration set, with certificate	350-8585	350-8585	350-8585	350-8585	350-8585
Temperature calibration set, without certificate	350-8584	350-8584	350-8584	350-8584	350-8584
Calibration weight, 50 g, E2	350-8241	350-8241	350-8241	350-8241	350-8241
Dust filter set for moisture analyzers	350-8687	350-8687	350-8687	350-8687	350-8687
Protective cover 320 for terminal, set of 5 pieces	–	350-8590	350-8590	350-8590	350-8590

Slide-in Modules, on demand only	EM 120-HR
USB Host	350-8665
LAN Ethernet connection	350-8666
WiFi connection	350-8667
Bluetooth connection	350-8668
PS 2 female & RS232 DB9 female	350-8670

Operating Temperature	Line Voltage, Tolerance	Power Consumption	Frequency
5°C .. 40°C (41°F .. 104°F)	115V / 230V, +15% / -20%	450 W	50 - 60 Hz

# SPECIAL PRODUCTS ACCESSORIES

Common Accessories	330/335 XM	365 EM
Printer LP4024, 230V / 115V	350-8391	350-8391
Bluetooth connection for Printer LP4024	-	350-8391-002
Paper roll for Printer LP4024, set of 4 pieces	350-8392	350-8392
Ribbon for Printer LP4024	PN 3953-013	PN 3953-013
Paper roll for Printer CBM910	350-8366	350-8366
Ribbon for Printer CBM910	350-8367	350-8367
Multiplexor for up to 7 instruments for serial (RS232) data transmission to PC or Printer (at least one instrument must be a series 320, 321, 330, 335, 365 or 490)	350-8513	350-8513
Data cable RJ45, 0.75m	350-8525	-
Data cable RJ45, 1.5m	350-8520	-
Data cable RJ45, 3m	350-8521	-
Adapter RJ45-DB9f, (PC/Printer LP4024)	350-8522	-
Adapter RJ45-DB25m, (Printer CBM910)	350-8524	-
Data cable RJ45-DB9f, 1.5m, (PC/Printer LP4024)	350-8557	-
Data cable RJ45-DB25m, 1.5m, (Printer CBM910)	350-8559	-
Data cable DB9m-DB9f, 1.5m, (PC/Printer LP 4024, 1:1)	-	350-8672
Data cable DB9m-DB25m, 1.5m, (Printer CBM910)	-	350-8673
USB cable A-B, 1.5m, (PC)	-	PN 3950-125
Interface box, Interface and power splitter	350-8940-000	350-8940-000
Interface box, LAN Ethernet connection	350-8940-001	350-8940-001
Interface box, WiFi connection	350-8940-002	350-8940-002
Interface box, Bluetooth connection	350-8940-003	350-8940-003
Anti-theft device, mechanical	350-8555	350-8555

PrecisaBUS Accessories (available on demand only)	330/335 XM	365 EM
Remote display free-standing, incl. 1.5 m cable	350-8504	-
Remote display with wall bracket, incl. 1.5 m cable	350-8516	-
RS232 interface box for data transmission, DB25f: - to PC, Printer or Barcode-Printer - from Barcode-Reader (350-8856) or reference balance	350-8506	-
Interface 20mA current loop passive	350-8526	-
LAN Ethernet connection	350-8573	-
WiFi connection	350-8588	-
Signal Lamp, indicator with 3 lamps, green / red / yellow	350-8510	-
Horn for signal lamp	350-8533	-
Input / Output module with 6 TTL inputs / 8 relay outputs	350-8509	-
CCE-Bar code scanner BCS5040, DB25m, with push button, to be connected to Interface RS232 350-8506	350-8856	-





















# TECHNICAL SPECIFICATIONS

Model	EM 120-HR	XM 60-HR	XM 60	XM 66	XM 50
<b>Heat Source</b>					
Radiator type	Halogen / Infrared / Dark	Halogen / Infrared / Dark	Halogen / Infrared / Dark	Halogen / Infrared / Dark	Halogen / Infrared / Dark
<b>Weighing system</b>					
Weighing range (g)	124	124	124	310	52
Pan Size (∅ mm)	100	100	100	100	100
Smallest sample weight (g)	0.2	0.2	0.2	0.2	0.2
Readability (g)	0.0001	0.0001	0.0001	0.0001	0.0001
Response time (s)	4 s	4 s	3 s	3 s	4 s
<b>Moisture Analysis</b>					
Readability (%)	0.001	0.001	0.01	0.01	0.01
<b>Readability (%)</b>					
at approx ... g / ...%	1 / 0.1	1 / 0.1	1 / 0.2	1 / 0.2	1 / 0.5
at approx ... g / ...%	10 / 0.01	10 / 0.01	10 / 0.02	10 / 0.02	10 / 0.02
<b>Results calculations</b>					
100% ... 0%	✓	✓	✓	✓	✓
0% ... 100%	✓	✓	✓	✓	✓
ATRO 100% ... 999%	✓	✓	✓	✓	✓
ATRO 0% ... 999%	✓	✓	✓	✓	✓
g/kg	✓	✓	✓	✓	✓
Residual weight (g)	✓	✓	✓	✓	✓
Weight loss (g)	✓	✓	✓	✓	✓
<b>Heating</b>					
Temperature range / Step (°C)	30 - 230 / 1	30 - 230 / 1	30 - 230 / 1	30 - 230 / 1	30 - 170 / 1
Intervals	3	boost + 1	boost + 1	boost + 1	boost + 1
Heating modes	standard, boost, smooth	standard, boost, smooth	standard, boost, smooth	standard, boost, smooth	standard, boost, smooth
Interval Switch-off (min)	0.1 - 99.9				
Interval Switch-off (%)	0.1 - 99.9				
<b>Switch-off Criteria</b>					
Auto Stop (d/s)	freely definable	freely definable	freely definable	freely definable	freely definable
Auto Stop (%/s)	freely definable	freely definable	freely definable		
Timer Stop (min)	0.1 - 240	0.1 - 240	0.1 - 240	0.1 - 240	0.1 - 240
Minimum Stop (%)	0.1 - 99.9				
AdaptStop	✓	✓	✓	✓	✓
<b>Sequence control system:</b>					
Weight loss / Residual weight	✓	✓	✓	✓	✓
Semi automatic standby temperature (°C)	30 - 100	30 - 100	30 - 100	30 - 100	30 - 100
<b>Monitoring:</b>					
Inspection window	✓	✓	✓	✓	✓
Buzzer	✓	✓	✓	✓	✓
<b>Print-out:</b>					
GLP	✓	✓	✓	✓	✓
Print interval (min)	0.1 - 10.0	0.1 - 10.0	0.1 - 10.0	0.1 - 10.0	0.1 - 10.0
User texts	✓				
Freely definable formats	✓				
Sample numbering	✓	✓	✓	✓	✓

# TECHNICAL SPECIFICATIONS

Model	EM 120-HR	XM 60-HR	XM 60	XM 66	XM 50
<b>Memory Capacity</b>					
Article (with all settings)	100	20	20	3 fix, 2 free	1
User texts	20				
<b>Operation</b>					
Display	Graphics, LCD, backlit	VFD, 20 characters, alphanumerical	VFD, 20 characters, alphanumerical	VFD, 20 characters, alphanumerical	VFD, 20 characters, alphanumerical
Keyboard	12 keys	10 keys	10 keys	10 keys	10 keys
Menu controlled	✓	✓	✓	✓	✓
Sample feed	manual	manual	manual	manual	manual
Password protection	✓	✓	✓	✓	✓
<b>Special Features</b>					
Weighing-in guidance	✓	✓	✓	✓	✓
Statistics	✓	✓	✓	✓	✓
Remote control (heater)	✓	✓	✓	✓	✓
Ash residue	✓	✓	✓	✓	
<b>Calibration</b>					
Balance	internal	external	external	external	external
Temperature	100°C and 160°C, selectable	100°C and 160°C, selectable	100°C and 160°C, selectable	100°C and 160°C, selectable	100°C and 160°C, selectable
<b>Miscellaneous</b>					
Clock for date and time	✓	✓	✓	✓	✓
PC / Printer interface	USB	RS 232	RS 232	RS 232	RS 232
Anti-theft protection	code and mechanical	code and mechanical	code and mechanical	code and mechanical	code and mechanical

# FEATURES & APPLICATIONS

Features		EM 120-HR	XM 60-HR	XM 60	XM 66	XM 50	Applications		EM 120-HR	XM 60-HR	XM 60	XM 66	XM 50
	Swiss Made	✓	✓	✓	✓	✓		Automatic repeatability test	✓				
	Backlit Graphic LCD	✓						Statistics	✓	✓	✓		✓
	Vacuum Fluorescent Display		✓	✓	✓	✓		Check weighing	✓	✓	✓	✓	✓
	Self-calibration system, fully automated	✓											
	External Calibration, with calibration warning		✓	✓	✓	✓							
	Clock (printout GLP/GMP, auto-cal etc.)	✓	✓	✓	✓	✓							
	USB device (for PC)	✓											
	Ethernet connection	AC											
	Wi-Fi connection	AC											
	Bluetooth connection	AC											
	USB host (barcode, flash drive, ...)	AC											
	Support IQ/OQ/PQ	✓	✓	✓	✓	✓							
	Anti-theft protection (mechanical and code)	✓	✓	✓	✓	✓							
	Easy alphanumeric input	✓											
	RS232 interface (for PC/printer)	✓	✓	✓	✓	✓							

# DIMENSIONS

## SERIES 330

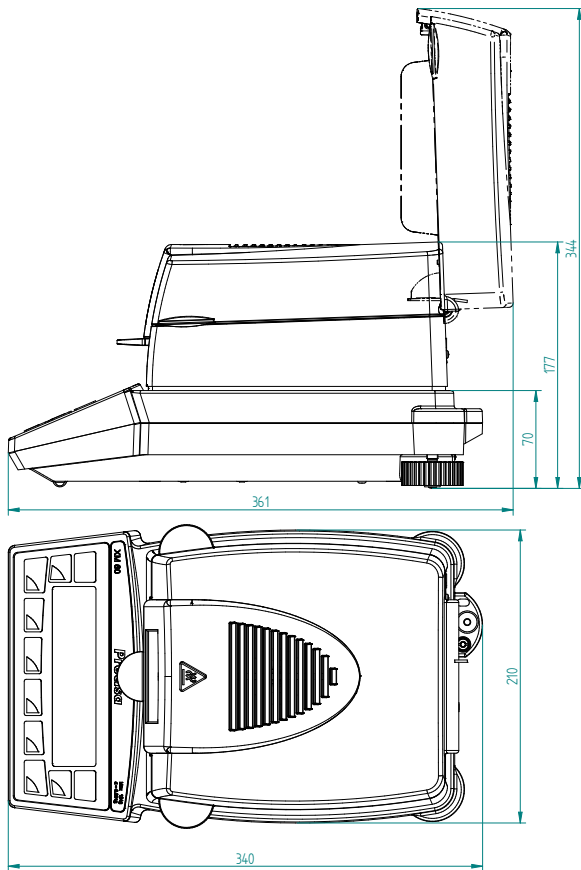

## SERIES 365

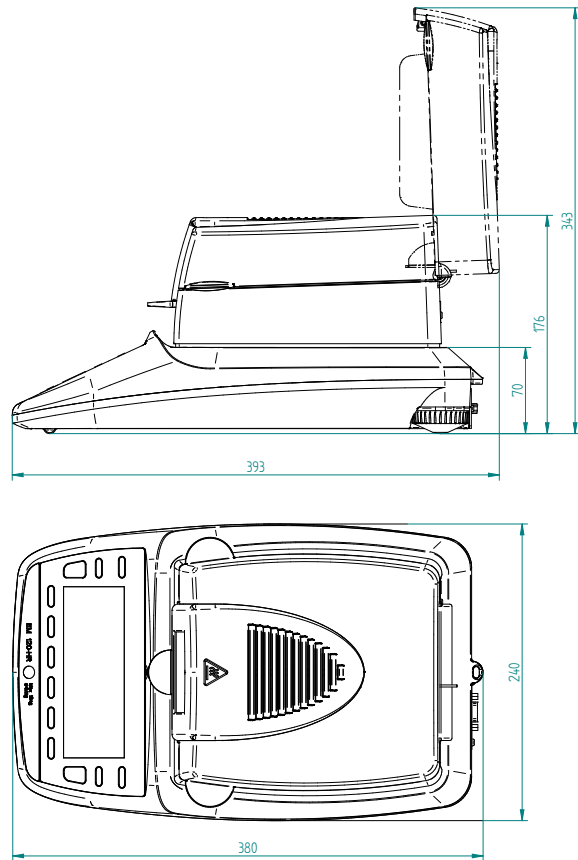

## TECHCOMP GROUP

In addition to Precisa, Techcomp Europe comprises of the following companies:



### Precisa Gravimetrics AG

Moosmattstrasse 32  
8953 Dietikon, Switzerland  
Tel. +41 44 744 28 28  
Fax +41 44 744 28 38  
Email: info@precisa.ch  
www.precisa.com

