



SWISS MADE
SWISS TECHNOLOGY

SERIES 390
PREMIUM MODELS



PRECISA DNA: ZERO COMPROMISE

Laboratory and industrial technicians are aware of the significance of the results they provide. That is why they are unwilling to accept any compromise in their field of work. This is precisely why leading specialists around the world place their trust in Precisa and have done for decades.

PRECISA DNA: SWISS PRECISION

Precisa products are prime examples of Swiss perfection and reliability. They are tried and tested in both demanding laboratory environments and industrial applications, and are subject to rigorous quality controls throughout the entire manufacturing process. Precisa invests continuously in developing new technologies and employs a highly qualified team. The result is a state-of-the-art range of precision instruments for the most exacting demands.

PRECISA DNA: SERIES 390

Precisa Gravimetrics provide 40 years of knowledge and experience in precision, balance technology and manufacturing. Made in Switzerland.

By owning an instrument by Precisa Gravimetrics you benefit from this unique and distinctive synergy. The Series 390 uses the latest technology by bringing together design and functionality. Meeting the required needs at the right time and being prepared for future tasks, this is the Series 390, this is the Precisa Gravimetrics DNA.



INTUITIVE & ERGONOMIC

With an easy to use menu, similar to the best smartphones, you will become familiar within seconds with your unique balance and exploit its full potential.

You can build your balance with those applications and features that suit your individual needs and requirements. We have four different Precisa 390 models: HF, HA, HE, HM.

Upgrades to the 390 Series balances are always available, with various options, accessories and unique Precisa applications. The draft shield windows are frameless and manufactured out of glass, offering you a barrier-free view and easier access into the weighing chamber. Removable glasses can be taken out for cleaning in seconds. Glass parts, all weighing pans and other components can be cleaned in a dishwasher.

Our new and brilliant balance series offers you the best ergonomics, including an ultimate low weighing pan level, the lowest on the market! Weighing processes can now be performed more comfortably, more ergonomically and with ease.

HIGH EFFICIENCY

You can speed up your daily routine and help yourself perform the weighing tasks much easier by utilizing the integrated non-contact IR-sensors.

Thanks to the new load cell and the state of the art signal processing, the weighing results are shown unbelievably fast and visualized with our newly developed stability indication system. The new, by default built-in electronics, as well as all the optional accessories, will amaze you for years with the ultimate weighing accuracy. Our user manual is built into the balance shown on the balance display and can be recalled and read at any time. Wherever you are with your balance, the user manual is always accessible to you.

We have expanded the same philosophy to cover everything in the balance series. We use colour coding throughout the instrument, starting from display, interface (UI) and mechanical components, so that you know without hesitation where to open a clip or perform a software action, how to activate a draft shield movement or how to customize the touchscreen.

FEATURES



7" Anti-Reflective Touchscreen Display

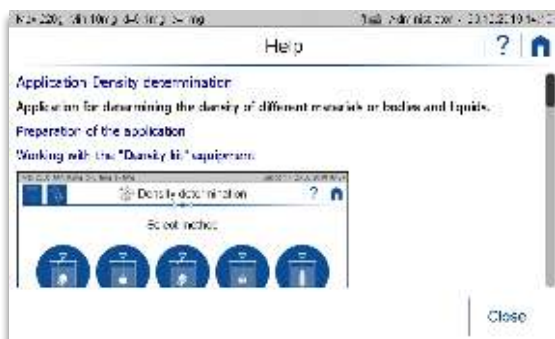

Integrated Help Functionality



Draft Shield with Automatic, Motorized or Manual Operation

PRECISA SERIES 390

Touchscreen

All balance functions are available at your fingertips on this smart and bright colour display. According to the built-in colour logic, all the touch active surfaces – marked by a key or a selection – are drafted in blue.

The balance user interface is intuitively easy to operate. The operation model took inspiration from the best smartphones as well as absorbing the most elegant features – just for you.

Tap on the touch active, blue coloured button and swipe with ease. There is no way to get lost because of the always available “Home” button, which takes you conveniently back to the start.

- 7” anti-reflective display
- Shock and scratch resistant
- Approved to operate with standard laboratory gloves
- UV resistant
- No buffering effects
- Frameless for perfect and easy cleaning

Help

We want to make your life easier!

Our help is available at any time, whenever you need it! Just press the Help icon and you instantly have our built-in user manual and relevant information available, with real context on the balance display.

No more wasting time searching the lost printed manual.

Draft Shield Protection

This was one of the topics at the hearts of our Swiss engineering team. The new door automation system is simple, yet very impressive. Electronically powered side doors with timing tuned, high-efficiency motors, ensure a gentle, smooth and precise opening to a desired position. Together with the door design, this state of the art draft shield is optimized to prevent any interference when weighing in fume hoods or ventilated laboratory rooms.

Our weighing chamber is designed in a way that neither powder nor liquids can contaminate the weighing system. The bottom plate is equipped with a tear-off edge preventing liquids to penetrate inside the casing. All draft shield parts, top and side glasses, weighing pan, can easily be removed without any tools and placed into your lab dishwasher.

The sophisticated door design without any guide rails or channels facilitates an affordable, easy to clean construction.

FEATURES

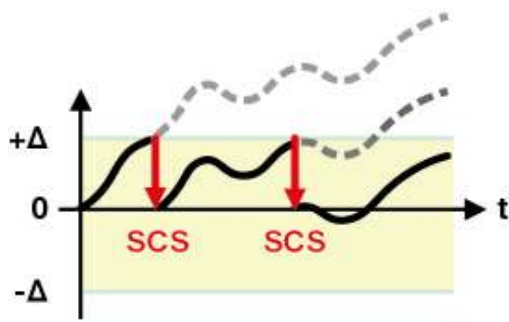

Self Calibration System (SCS)

PRECISA SERIES 390

Self Calibration System (SCS)

Is an innovative adjustment system, meaning you will always have a perfectly adjusted weighing scale. The system operates automatically or manually and detects all changes in the environment by time including temperature and air pressure change.

We have naturally - to confirm the weighing accuracy - designed the mechanical system in such a way that the internal weights are protected against liquid, dust and any foreign particles.

Our 390 series balances promises you the best possible accuracy and precision for years to come.

Stability-Indicator, Visually Predictive

Our new optical stability indicator provides visual indication of environment disturbances and provides real time information about the balance environment. The indicator displays how the weighing accuracy develops in your daily working environment and reduces potential uncertainties. The stability tracker display simply indicates to the balance user when the balance has high ambient stability and takes longer to change with greater instability.

You can now - by observing the orbital symbol - intuitively quickly predict a weighing result or wait until the completion of the circle so that the weighing result is definitely fixed.

Electronic Levelling for Improved Precision

A visual warning appears on the display if the instrument is tilted outside the internally stored levelling tolerances. To readjust the levelling, an electronic virtual guided levelling display will be activated and instruct you on how to get your instrument back to the correctly levelled position.

Environmental Noise Cancelling

Improved digital filter with sophisticated mathematical algorithms to cancel the effects of environmental noise, as air turbulence and ground vibration.



Stability-Indicator, Visually Predictive

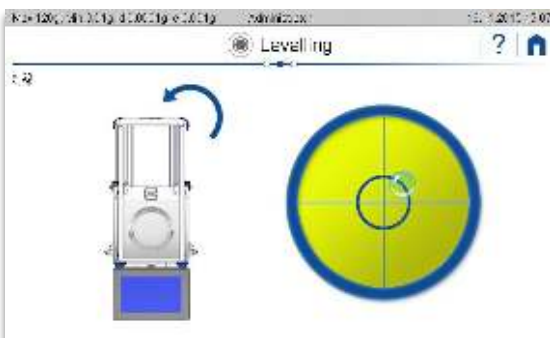

Electronic Levelling for Improved Precision

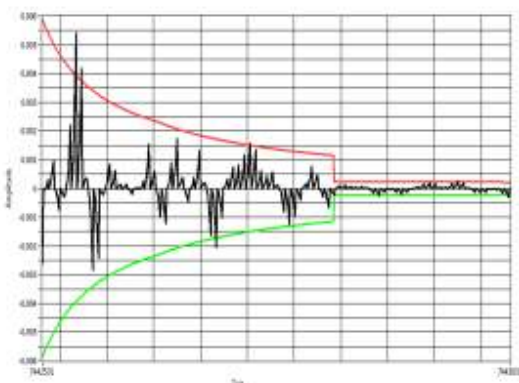

ENC™ Environmental Noise Cancelling System

FEATURES



Communication & Interfaces

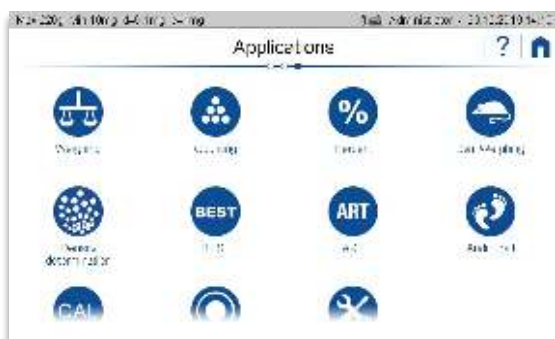

Applications

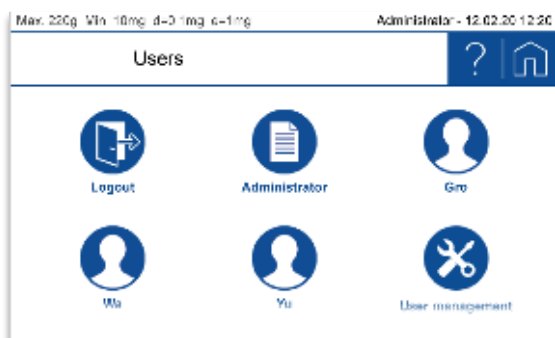

User Management

PRECISA SERIES 390

Communication & Interfaces

Series 390 is ready to follow your communication needs whether you are already working in a paperless lab with LIMS or not.

We have equipped the balance with all the standard interfaces that are common today

- 2 x USB type A (host)
- 1 x USB type B (device)
- 1 x 100M Ethernet

On the rear of the instrument an RS232 and USB type B interface are included. Therefore connecting your balance to a PC or RS232 printer for protocol printout is made easy.

Additional interfaces such as WiFi, Bluetooth etc. are available as accessories.

Applications

You can equip your series 390 balance with useful applications, similar to smartphones. Applications can be installed easily by any user with the appropriate authorization and you will not need any specialist.

Your requirements today may not be the same as they may be in the future. You might need to find new working methods to make the work easier. There are affordable Precisa apps which can help you and make your life a lot easier.

This exclusive feature is available from Precisa Gravimetrics only.

User Management

Your balance can be set and optimized for various users by using the built-in, extensive user management system.

A user profile is set just once. And when starting work with your balance, you just choose your own profile and the balance is ready for you, the way you need it, personalized with broad access rights, or just set with the basic operation facilities, like right or left handed user.

FEATURES

PRECISA SERIES 390

Touchless Sensor (TLS)

These are very helpful, when you perform daily routines with your balances, like opening a draft shield door, taring or zeroing the balance or performing a special function. You can set the built-in touchless sensors to activate those functions by a simple hand motion.

The sensors can be adjusted with three detection angles to follow your own, personal needs and tasks.

It is possible to upgrade balances which are not fitted with this feature at a later stage.

Electrostatic Cancellation System (ECS)

All electrostatic charges are neutralized quickly by our built-in AC pulse technique utilizing an ion neutralizing system, which is engineered and manufactured together with Panasonic.

Operation is easy. Just by placing the sample into the weighing chamber, your sample is automatically neutralized when the draft shield is closed. No laborious search for an externally installed ionizer.

Retrofit installation of an ECS is possible by a local Precisa engineer.

Ambient Observation System (AOS)

Various ambient air conditions affect the weighing result. Therefore meteorological factors such as air pressure, air humidity and air temperature are recorded with AOS. This is done in real time and inside the weighing chamber where the sample is placed.

This important parameter supports the traceability and can also provide an indication of the ambient status. The information can be recorded, used just as an indication or as an additional parameter when calculating the weighing result with the app BEST.



Touchless Sensor (TLS)



Electrostatic Cancellation System (ECS)



Ambient Observation System (AOS)

MODELS

HF HA

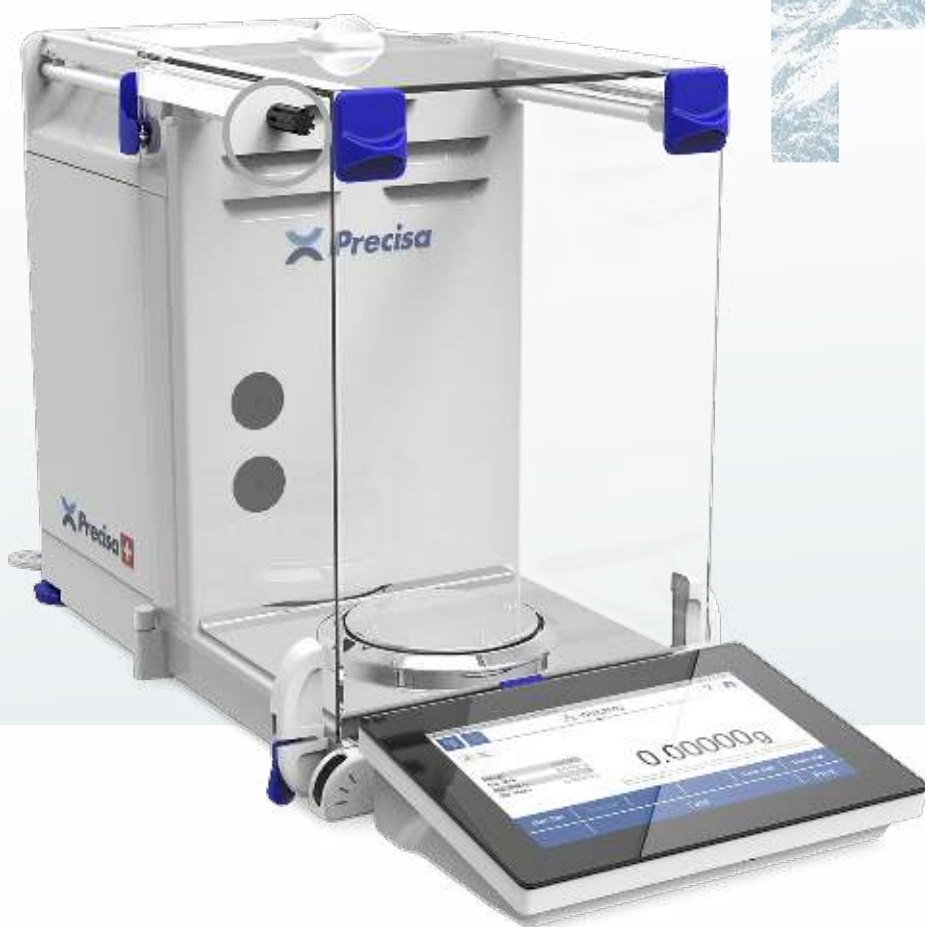

390 HF/HA

If you want to be prepared for all weighing challenges, choose the model HF. The top of the range, with all Precisa's high-end technologies. They have touchless sensors which are programmed with different functions including contactless draft shield opening, tare, print and other useful functions. The various applications make daily work easier and work perfectly together with ECS and AOS. ECS and AOS ensure the most reliable weighing results under all conditions and with traceability. Weighing at the peak of available technology, that's the HF.

The HA model is the complete 390 series balance and you can easily upgrade the unit with all available accessories. With the automated draft shield already installed, and the full set of applications you will feel ready for anything. This high-end instrument can be upgraded at any time with ECS and AOS systems by a Precisa trained service engineer.

Model	Main Differences in Features
HF	+ Electric draft shield + TLS + AOS + ECS
HA	+ Electric draft shield + TLS
HE	+ Electric draft shield
HM	Mechanical draft shield

MODELS

HE HM

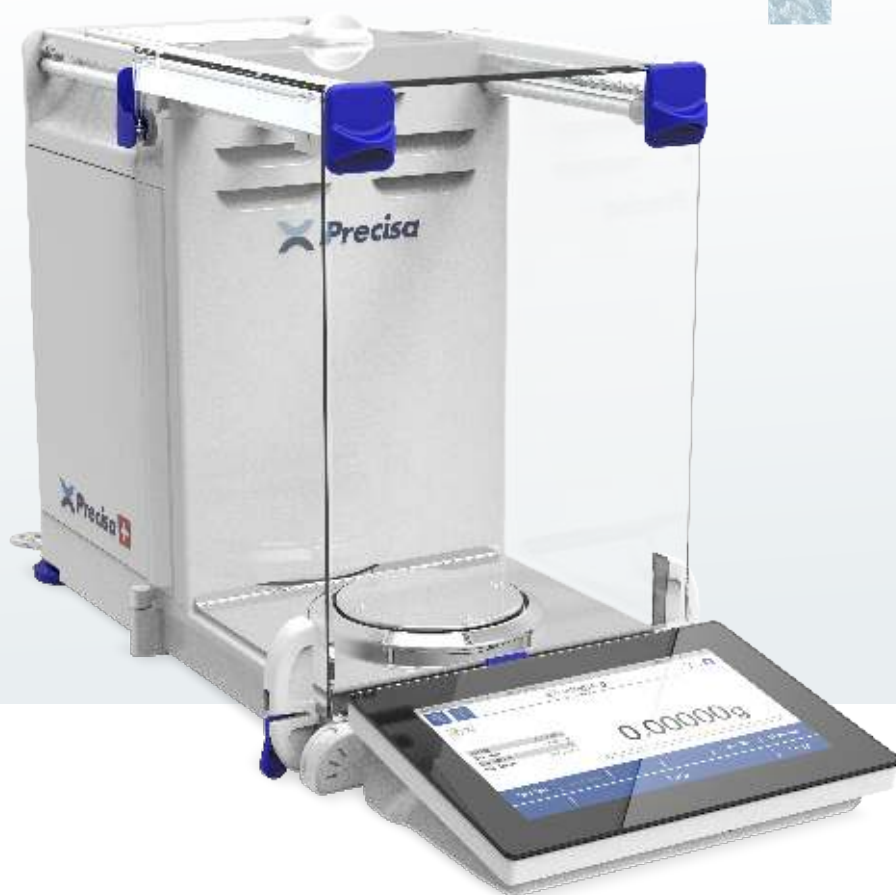

390 HE/HM

With the series 390, you can enter the 390 Club with two models, HE and HM. With both models you get the most important features and functionalities as well as the option to personalize and upgrade the model HE. The electric draft shield can be easily opened by pressing a key and if you want to enjoy the comfort of the touchless sensor you can later install it. So count on the HE for your daily weighing jobs at an attractive price.

The HE model is also ready for being extended with all other applications that could be useful some day. Should you face problems with electrostatics, upgrading ECS and even AOS is possible. The 390 HM, with manual draft shield opening is the economic version with the same measurement technology as the sister models HE, HA, HF.

Model	Main Differences in Features
HF	+ Electric draft shield + TLS + AOS + ECS
HA	+ Electric draft shield + TLS
HE	+ Electric draft shield
HM	Mechanical draft shield

MODELS

HF MODEL

Model	Capacity	Readability	Repeatability (Load >5%)	Min. Weight (1%, k=2, Load >5%)	Linearity	Pan Size (mm)	Class / „e”	Response Time	Item No.
Semi-Micro Balances									Net weight 13 kg
HF 125SM	125 g	0.01 mg	0.010 mg	2.0 mg*	0.06 mg	ø 80	I / 1 mg	8 s	390-9104-009
HF 125SM-FR	61 g - 125 g	0.01 mg / 0.1 mg	0.010 mg 0.040 mg	2.0 mg*	0.06 mg / 0.1 mg	ø 80	I / 1 mg	8 / 2 s	390-9106-009
HF 225SM-DR	102 g / 225 g	0.01 mg / 0.1 mg	0.010 mg 0.040 mg	2.0 mg*	0.06 mg / 0.2 mg	ø 80	I / 1 mg	8 / 2 s	390-9107-009
HF 225SM-FR	61 g - 225 g	0.01 mg / 0.1 mg	0.010 mg 0.040 mg	2.0 mg*	0.06 mg / 0.2 mg	ø 80	I / 1 mg	8 / 2 s	390-9108-009
Analytical Balances									Net weight 13 kg
HF 120A	120 g	0.1 mg	0.04 mg	8.2 mg*	0.1 mg	ø 90	I / 1 mg	2 s	390-9257-009
HF 220A	220 g	0.1 mg	0.04 mg	8.2 mg*	0.2 mg	ø 90	I / 1 mg	2 s	390-9258-009
HF 320A	320 g	0.1 mg	0.04 mg	8.2 mg*	0.2 mg	ø 90	I / 1 mg	3 s	390-9259-009
HF 520A	520 g	0.1 mg	0.06 mg	12 mg*	0.4 mg	ø 90	–	4 s	390-9260-009

HA MODEL

Model	Capacity	Readability	Repeatability (Load >5%)	Min. Weight (1%, k=2, Load >5%)	Linearity	Pan Size (mm)	Class / „e”	Response Time	Item No.
Semi-Micro Balance									Net weight 13 kg
HA 125SM	125 g	0.01 mg	0.010 mg	2.0 mg*	0.06 mg	ø 80	I / 1 mg	8 s	390-9104-003
HA 125SM-FR	61 g - 125 g	0.01 mg / 0.1 mg	0.010 mg 0.040 mg	2.0 mg*	0.06 mg / 0.1 mg	ø 80	I / 1 mg	8 / 2 s	390-9106-003
HA 225SM-DR	102 g / 225 g	0.01 mg / 0.1 mg	0.010 mg 0.040 mg	2.0 mg*	0.06 mg / 0.2 mg	ø 80	I / 1 mg	8 / 2 s	390-9107-003
HA 225SM-FR	61 g - 225 g	0.01 mg / 0.1 mg	0.010 mg 0.040 mg	2.0 mg*	0.06 mg / 0.2 mg	ø 80	I / 1 mg	8 / 2 s	390-9108-003
Analytical Balances									Net weight 13 kg
HA 120A	120 g	0.1 mg	0.04 mg	8.2 mg*	0.1 mg	ø 90	I / 1 mg	2 s	390-9257-003
HA 220A	220 g	0.1 mg	0.04 mg	8.2 mg*	0.2 mg	ø 90	I / 1 mg	2 s	390-9258-003
HA 320A	320 g	0.1 mg	0.04 mg	8.2 mg*	0.2 mg	ø 90	I / 1 mg	3 s	390-9259-003
HA 520A	520 g	0.1 mg	0.06 mg	12 mg*	0.4 mg	ø 90	–	4 s	390-9260-003

* USP Min. weight (0.1%, k=2, Load >5%) = Min. weight x 10

MODELS

HE MODEL

Model	Capacity	Readability	Repeatability (Load >5%)	Min. Weight (1%, k=2, Load >5%)	Linearity	Pan Size (mm)	Class / „e“	Response Time	Item No.
Semi-Micro Balances									Net weight 13 kg
HE 125SM	125 g	0.01 mg	0.010 mg	2.0 mg*	0.06 mg	ø 80	I / 1 mg	8 s	390-9104-002
HE 125SM-FR	61 g - 125 g	0.01 mg / 0.1 mg	0.010 mg 0.040 mg	2.0 mg*	0.06 mg / 0.1 mg	ø 80	I / 1 mg	8 / 2 s	390-9106-002
HE 225SM-DR	102 g / 225 g	0.01 mg / 0.1 mg	0.010 mg 0.040 mg	2.0 mg*	0.06 mg / 0.2 mg	ø 80	I / 1 mg	8 / 2 s	390-9107-002
HE 225SM-FR	61 g - 225 g	0.01 mg / 0.1 mg	0.010 mg 0.040 mg	2.0 mg*	0.06 mg / 0.2 mg	ø 80	I / 1 mg	8 / 2 s	390-9108-002
Analytical Balances									Net weight 13 kg
HE 120A	120 g	0.1 mg	0.04 mg	8.2 mg*	0.1 mg	ø 90	I / 1 mg	2 s	390-9257-002
HE 220A	220 g	0.1 mg	0.04 mg	8.2 mg*	0.2 mg	ø 90	I / 1 mg	2 s	390-9258-002
HE 320A	320 g	0.1 mg	0.04 mg	8.2 mg*	0.2 mg	ø 90	I / 1 mg	3 s	390-9259-002
HE 520A	520 g	0.1 mg	0.06 mg	12 mg*	0.4 mg	ø 90	–	4 s	390-9260-002

HM MODEL

Model	Capacity	Readability	Repeatability (Load >5%)	Min. Weight (1%, k=2, Load >5%)	Linearity	Pan Size (mm)	Class / „e“	Response Time	Item No.
Semi-Micro Balances									Net weight 13 kg
HM 125SM	125 g	0.01 mg	0.010 mg	2.0 mg*	0.06 mg	ø 80	I / 1 mg	8 s	390-9104-001
HM 125SM-FR	61 g - 125 g	0.01 mg / 0.1 mg	0.010 mg 0.040 mg	2.0 mg*	0.06 mg / 0.1 mg	ø 80	I / 1 mg	8 / 2 s	390-9106-001
HM 225SM-DR	102 g / 225 g	0.01 mg / 0.1 mg	0.010 mg 0.040 mg	2.0 mg*	0.06 mg / 0.2 mg	ø 80	I / 1 mg	8 / 2 s	390-9107-001
HM 225SM-FR	61 g - 225 g	0.01 mg / 0.1 mg	0.010 mg 0.040 mg	2.0 mg*	0.06 mg / 0.2 mg	ø 80	I / 1 mg	8 / 2 s	390-9108-001
Analytical Balances									Net weight 13 kg
HM 120A	120 g	0.1 mg	0.04 mg	8.2 mg*	0.1 mg	ø 90	I / 1 mg	2 s	390-9257-001
HM 220A	220 g	0.1 mg	0.04 mg	8.2 mg*	0.2 mg	ø 90	I / 1 mg	2 s	390-9258-001
HM 320A	320 g	0.1 mg	0.04 mg	8.2 mg*	0.2 mg	ø 90	I / 1 mg	3 s	390-9259-001
HM 520A	520 g	0.1 mg	0.06 mg	12 mg*	0.4 mg	ø 90	–	4 s	390-9260-001

* USP Min. weight (0.1%, k=2, Load >5%) = Min. weight x 10

OPTIONS AND ACCESSORIES

Options	HF	HA	HE	HM
EU-Verification according to 2014/31/EU by Precisa (initial verification), available only for balances with EU/OIML type approval	350-8930	350-8930	350-8930	350-8930
TLS Touchless sensors to operate draft shield, tare, print, ...	standard	standard	350-8047	–
ECS Electrostatic Cancellation System & AOS Ambient Observation System all-round care package	standard	390-8500-000	390-8500-000	–
ECS Electrostatic Cancellation System	standard	390-8500-001	390-8500-001	–
AOS Ambient Observation System	standard	390-8500-002	390-8500-002	–
Extension cable Ethernet only	390-8501-001	390-8501-001	390-8501-001	390-8501-001
Extension cable USB host (type A) only	390-8501-002	390-8501-002	390-8501-002	390-8501-002
Extension cable USB device (type B) only	390-8501-003	390-8501-003	390-8501-003	390-8501-003
Extension cable USB host double (2 type A) only	390-8501-004	390-8501-004	390-8501-004	390-8501-004
Extension cable Ethernet + USB host (type A)	390-8501-021	390-8501-021	390-8501-021	390-8501-021
Extension cable Ethernet + USB host (type B)	390-8501-031	390-8501-031	390-8501-031	390-8501-031
Extension cable Ethernet + USB host double (2 type A)	390-8501-041	390-8501-041	390-8501-041	390-8501-041
Extension cable USB host (type A) + USB host (type A)	390-8501-022	390-8501-022	390-8501-022	390-8501-022
Extension cable USB host (type A) + USB device (type B)	390-8501-032	390-8501-032	390-8501-032	390-8501-032
Extension cable USB device (type B) + USB host double (2 type A)	390-8501-043	390-8501-043	390-8501-043	390-8501-043
Extension cable PS2f-PS2m, length 1m, 390 (for terminal)	350-7316	350-7316	350-7316	350-7316

Applications	HF	HA	HE	HM
BEST Buoyancy error suppression technology	standard	standard	350-8738-001	350-8738-001
Density determination	standard	standard	350-8738-002	350-8738-002

Accessories	HF	HA	HE	HM
Hook for weighing below the balance	350-8527	350-8527	350-8527	350-8527
VasoFrame 390	350-8721	350-8721	350-8721	350-8721
AeroPan 390 Ø 80mm for 0.01mg balances	350-8728	350-8728	350-8728	350-8728
AeroPan 390 Ø 90mm for 0.1mg balances	350-8729	350-8729	350-8729	350-8729
Density kit, Container size Ø 75mm, h= 100mm	350-8719	350-8719	350-8719	350-8719
Density kit solids only (w/o Glass body and Hook), Container size Ø 75mm, h= 100mm	350-8720	350-8720	350-8720	350-8720
Glass body 10ccm for density determination of liquids	350-7054	350-7054	350-7054	350-7054
Downholder for samples with density < 1g/cm3	350-7194	350-7194	350-7194	350-7194
Evaporation trap for pipette calibration complete for 0.01mg and 0.1mg balances	350-8717	350-8717	350-8717	350-8717
Adapter to assemble Eppendorf Humidity Trap for 0.01mg and 0.1mg balances	350-8718	350-8718	350-8718	350-8718
Single foot switch for one function: tare, print, ...	350-8747-001	350-8747-001	350-8747-001	350-8747-001
Double foot switch USB for two functions: tare and print, tare and ...	350-8747-002	350-8747-002	350-8747-002	350-8747-002
WiFi connection	350-8935	350-8935	350-8935	350-8935









































Operation Temperature	Line Voltage, Tolerance	Power Consumption	Frequency
5 .. 40 °C (41°F..104°F)	115V / 230V, +15% / -20%	18 VA	50 - 60 Hz

SPECIAL PRODUCTS ACCESSORIES

Common Accessories	390 HF/HA/HE/HM
Printer LP4024, 230V / 115V	350-8391
Bluetooth connection for Printer LP4024	350-8391-002
Paper roll for Printer LP4024, set of 4 pieces	350-8392
Ribbon for Printer LP4024	PN 3953-013
Paper roll for Printer CBM910	350-8366
Ribbon for Printer CBM910	350-8367
Data cable DB9m-RJ45, 1.5m, for balance used as reference balance	350-8661
Data cable DB9m-DB9f, 1.5m, (PC/Printer LP 4024, 1:1)	350-8672
Data cable DB9m-DB25m, 1.5m, (Printer CBM910)	350-8673
USB cable A-B, 1.5m, (PC)	PN 3950-125
Interface box, Interface and power splitter	350-8940-000
Interface box, Bluetooth connection	on demand
HID cable, RS232, DB9m-USB-A, 1.5m, (PC), (x: 0=e, 1=d, 2=f)	on demand
External USV accu power pack for continuous operation	350-8662
Power splitter cable	350-8399
Anti-theft device, mechanical	350-8555
Carat bowl (for diamond weighing)	350-8322

PrecisaBUS Accessories	390 HF/HA/HE/HM
Signal Lamp, indicator with 3 lamps, green / red / yellow	350-8734
Horn for signal lamp	350-8533
Input / Output module with 6 TTL inputs / 8 relay outputs	on demand

FEATURES & APPLICATIONS

Features		HF	HA	HE	HM	Applications		HF	HA	HE	HM
	Swiss Made	✓	✓	✓	✓		Units g, mg, ozt, lb, tael, etc.	✓	✓	✓	✓
	Color Touch Screen	✓	✓	✓	✓		Percent weighing	✓	✓	✓	✓
	Self Calibration System	✓	✓	✓	✓		Piece counting	✓	✓	✓	✓
	Motorized Draft Shield (works with TLS)	✓	✓	✓	✓		Animal weighing	✓	✓	✓	✓
	RS232 interface for PC / printer	✓	✓	✓	✓		Dynamic difference weighing	✓	✓	✓	✓
	Identifier and label handling	✓	✓	✓	✓		Free conversion Area Conversion	✓	✓	✓	✓
	USB Device	✓	✓	✓	✓		Statistics	✓	✓	✓	✓
	USB host (barcode, flash drive, ...)	✓	✓	✓	✓		Recorder	✓	✓	✓	✓
	Ethernet connection	✓	✓	✓	✓		Minimum sample weight	✓	✓	✓	✓
	Bluetooth connection	OD	OD	OD	OD		Automatic repeatability test	✓	✓	✓	✓
	Wi-Fi connection	350-8935	350-8935	350-8935	350-8935		Maintenance Service Package	✓	✓	✓	✓
	Support IQ/OQ/PQ	✓	✓	✓	✓		Net total application: Add up summation (Dosing program)	✓	✓	✓	✓
	Anti-theft protection with password plus mechanical security	✓	✓	✓	✓		Checkweighing	✓	✓	✓	✓
	Direct tare and reference weigh entry (manually)	✓	✓	✓	✓		Density determination	✓	✓	350- 8738-002	350- 8738-002
	Clock (printout GLP/GMP, auto-cal etc.)	✓	✓	✓	✓		Buoyancy error suppression technology	✓	✓	350- 8738-001	350- 8738-001
	Below balance weighing	✓	✓	✓	✓						
	Easy alphanumeric input	✓	✓	✓	✓						
	Touchless sensors to operate draft shield, tare, print, ...	✓	✓	350-8047							
	Electrostatic Cancellation System	✓	390- 8500-001	390- 8500-001							
	Ambient Observation System	✓	390- 8500-002	390- 8500-002							
	Human Interface Device (to PC)	OD	OD	OD	OD						
	EU/OIML type approval	350-8930	350-8930	350-8930	350-8930						
	External I/O (Tare, Print, ..., Realis)	OD	OD	OD	OD						
	Integrated Alibi Memory (as part of EC-Verification)	OD	OD	OD	OD						
	Integrated Audit Trail	✓	✓	✓	✓						

AC = accessory or optional built-in at factory
OD = on demand

DIMENSIONS

390 ANALYTICAL MODELS

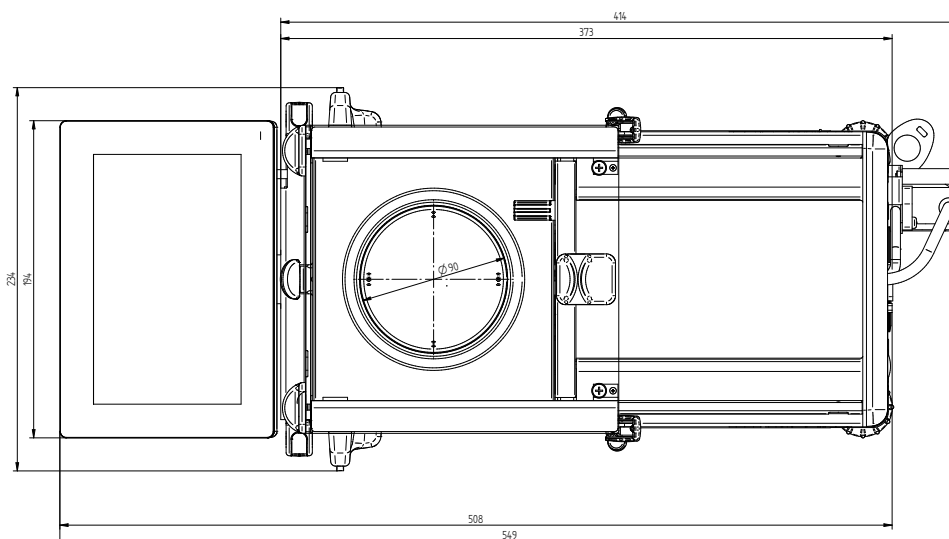
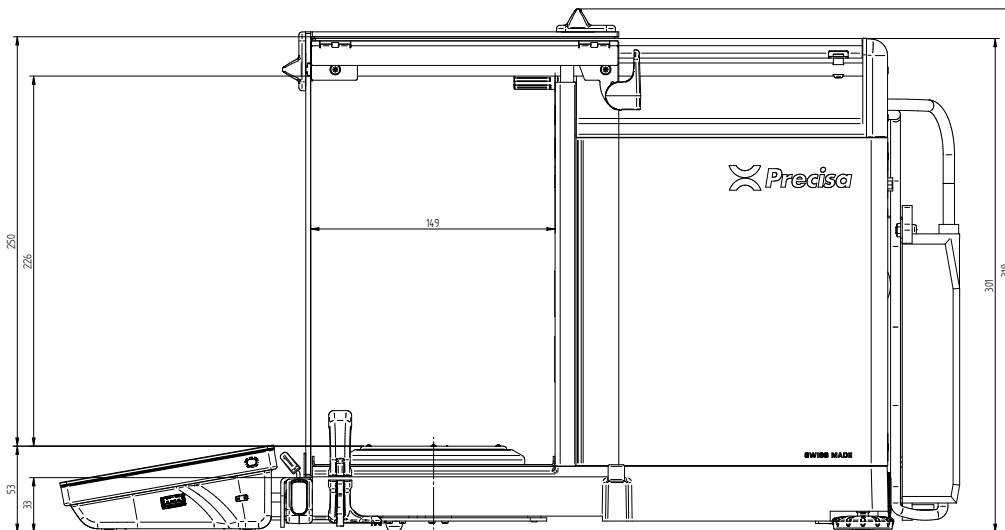

390 SEMI-MICRO MODELS

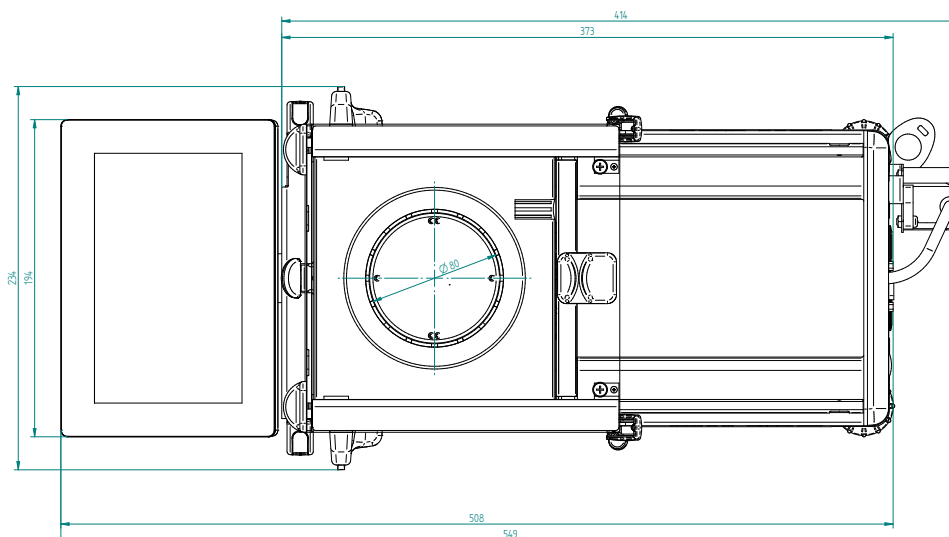

TECHCOMP GROUP

In addition to Precisa, Techcomp Europe comprises of the following companies:

